

aiwa

Compact Disc Stereo System

NSX-AJ310

U

COMPACT
disc
DIGITAL AUDIO

For assistance and information

call toll free 1-800-BUY-AIWA
(United States and Puerto Rico)

8B-NFY-913-01

001215AKH-AR-M

— OPERATING INSTRUCTIONS

En (English)

PRECAUTIONS

Read these Operating Instructions carefully and completely before operating the unit. All precautions on this booklet and on the unit should be strictly followed. Keep the Operating Instructions for future reference.

WARNING

To reduce the risk of fire or electric shock, do not expose this appliance to rain or moisture.

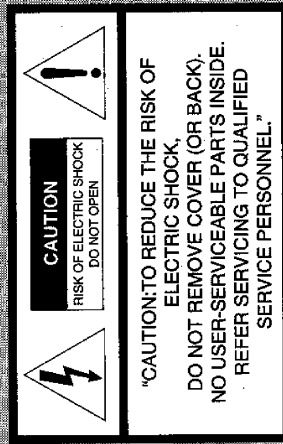

Explanation of Graphical Symbols:

The lightning flash with arrowhead symbol, within an equilateral triangle, is intended to alert the user to the presence of uninsulated "dangerous voltage" within the product's enclosure that may be of sufficient magnitude to constitute a risk of electric shock to persons.

The exclamation point within an equilateral triangle is intended to alert the user to the presence of important operating and maintenance (servicing) instructions in the literature accompanying the appliance.

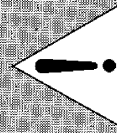
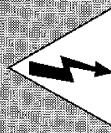

Installation

1 Water and moisture — Do not use this unit near water, such as near a bathtub, washbowl, swimming pool, or the like.

2 Heat — Do not use this unit near sources of heat, including heating vents, stoves, or other appliances that generate heat. It also should not be placed in temperatures less than 5°C (41°F) or greater than 35°C (95°F).

3 Mounting surface — Place the unit on a flat, even surface.

4 Ventilation — The unit should be situated with adequate space around it so that proper heat ventilation is assured. Allow 10 cm (4 in.) clearance from the rear and the top of the unit, and 5 cm (2 in.) from each side.

- Do not place the unit on a bed, rug, or similar surface that may block the ventilation openings.

- Do not install the unit in a bookcase, cabinet, or airtight rack where ventilation may be impeded.

5 Objects and liquid entry — Take care that objects or liquids do not get inside the unit through the ventilation openings.

6 Carts and stands — When placed or mounted on a stand or cart, the unit should be moved with care. Quick stops, excessive force, and uneven surfaces may cause the unit or cart to overturn or fall.

7 Condensation — Moisture may form on the CD pickup lens when:

- The unit is moved from a cold spot to a warm spot
 - The heating system has just been turned on
 - The unit is used in a very humid room
 - The unit is cooled by an air conditioner
- When this unit has condensation inside, it may not function normally. Should this occur, leave the unit for a few hours, then try to operate again.

8 Wall or ceiling mounting — The unit should not be mounted on a wall or ceiling, unless specified in the Operating Instructions.

Electric Power

1 Power sources — Connect this unit only to power sources specified in the Operating Instructions, and as marked on the unit.

2 Polarization — As a safety feature, some units are equipped with polarized AC power plugs which can only be inserted one way into a power outlet. If it is difficult or impossible to insert the AC power plug into an outlet, turn the plug over and try again. If it still does not easily insert into the outlet, please call a qualified service technician to service or replace the outlet. To avoid defeating the safety feature of the polarized plug, do not force it into a power outlet.

3 AC power cord

- When disconnecting the AC power cord, pull it out by the AC power plug. Do not pull the cord itself.

- Never handle the AC power plug with wet hands, as this could result in fire or shock.

- Power cords should be firmly secured to avoid being severely bent, pinched, or walked upon. Pay particular attention to the cord from the unit to the power outlet.

- Avoid overloading AC outlets and extension cords beyond their capacity, as this could result in fire or shock.

4 Extension cord — To help prevent electric shock, do not use a polarized AC power plug with an extension cord, receptacle, or other outlet unless the polarized plug can be completely inserted to prevent exposure of the blades of the plug.

5 When not in use — Unplug the AC power cord from the power outlet if the unit will not be used for several months or more. When the cord is plugged in, a small amount of current continues to flow to the unit, even when the power is turned off.



Outdoor Antenna

- 1 Power lines — When connecting an outdoor antenna, make sure it is located away from power lines.
- 2 Outdoor antenna grounding — Be sure the antenna system is properly grounded to provide protection against unexpected voltage surges or static electricity build-up. Article 810 of the National Electrical Code, ANSI/NFPA 70, provides information on proper grounding of the mast, supporting structure, and the lead-in wire to the antenna discharge unit, as well as the size of the grounding unit, connection to grounding terminals, and requirements for grounding terminals themselves.

Antenna Grounding According to the National Electrical Code

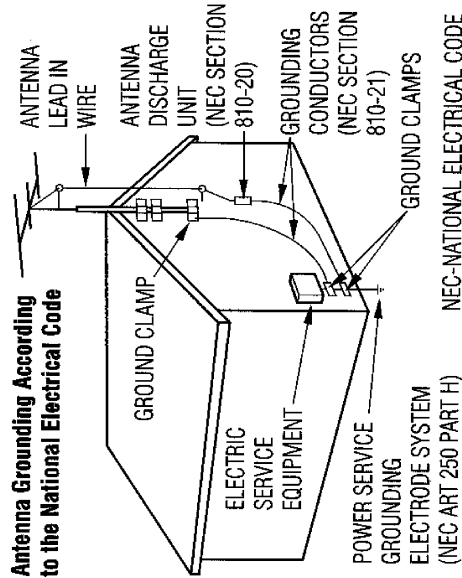

Maintenance

Clean the unit only as recommended in the Operating Instructions.

Damage Requiring Service

- Have the units serviced by a qualified service technician if:
- The AC power cord or plug has been damaged
 - Foreign objects or liquid have gotten inside the unit
 - The unit has been exposed to rain or water
 - The unit does not seem to operate normally
 - The unit exhibits a marked change in performance
 - The unit has been dropped, or the cabinet has been damaged
- DO NOT ATTEMPT TO SERVICE THE UNIT YOURSELF.

TABLE OF CONTENTS

PRECAUTIONS 2
 PREPARATIONS 4
 PARTS AND CONTROLS 5
 ADJUSTMENTS BEFORE OPERATIONS 8
 CD OPERATIONS 10
 RADIO OPERATIONS 12
 TAPE OPERATIONS 14
 SOUND ADJUSTMENTS 17
 TIMER OPERATIONS 18
 REFERENCE 20

System and accessories

- NSX-AJ310 Remote control
- CX-NAJ310 Compact disc stereo cassette receiver
- SX-NAJ312 Front speakers
- FM antenna
- AM antenna

OWNER'S RECORD

Record the model number and serial number of your set (found at the rear of your set) below. Refer to them when contacting your Aiwa dealer.

Model No. _____

Serial No. _____



As an ENERGY STAR® Partner, AIWA has determined that this product meets the ENERGY STAR® guidelines for energy efficiency.

PREPARATIONS

Connection

Plug in the AC power cord to the AC power outlet after all other connections are made.

- 1 Connect the front speakers.

Connect the right front speaker to the SPEAKERS R terminals and the left to the SPEAKERS L terminals. The speaker cords with the white stripes go to the \oplus terminals.

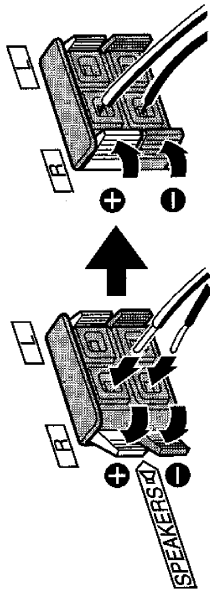

- 2 Connect the supplied antennas.

Connect the FM antenna to the FM 75 Ω terminals and the AM antenna to the AM LOOP terminals.

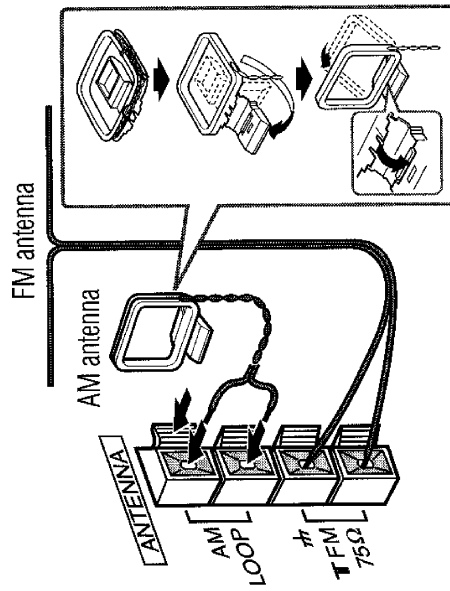

Remote control

Detach the battery compartment lid at the rear of the remote control and insert two R6 (size AA) batteries with correct polarity.

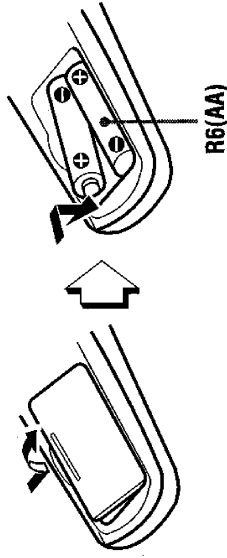

- Replace the batteries with new ones when the operational distance between the remote control and main unit becomes shorter.
- Remove the batteries if the unit is not going to be used for an extended period of time.
- The remote control may not operate if it is used under intense sunlight, etc., or if its line of sight is obstructed.
- "4" and "5" of DISC DIRECT PLAY on the remote control cannot be used on this system.

- 3 Connect the AC power cord to an AC outlet.

When the AC power cord is connected to an AC outlet for the first time, DEMO appears on the display.

To deactivate the DEMO, press DEMO/ECC.

- Do not short-circuit the \oplus and \ominus speaker cord leads.
- Do not leave objects generating magnetism or objects affected by magnetism near the speakers.

PARTS AND CONTROLS

Main unit: rear

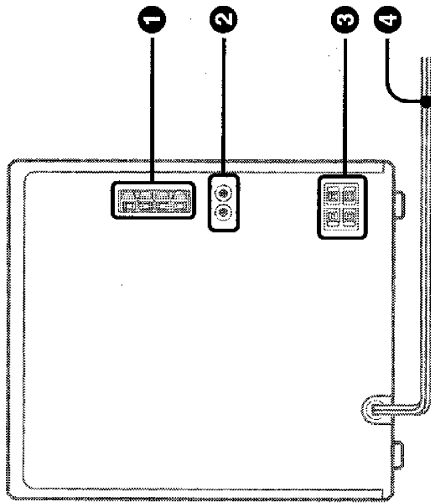

1 AM LOOP, FM 75 Ω terminals

Plug in the supplied AM and FM antennas here.

2 VIDEO/AUX jacks

Accepts analog sound signals from external equipment. Connect using an optional connecting cable with RCA phono plugs (red plug to R jack, white plug to L jack). Refer also to the operating instructions of your equipment. To switch function to external input, press VIDEO/AUX to select the VIDEO (AUX/TV) function.

Tip:

To change the displayed name for this function, turn the unit on, then hold down VIDEO/AUX and press POWER. Repeat the procedure to select one of "VIDEO", "AUX" or "TV".

3 SPEAKERS terminals

Connect the speaker cord of the supplied front speakers here.

4 AC power cord



Main unit: front

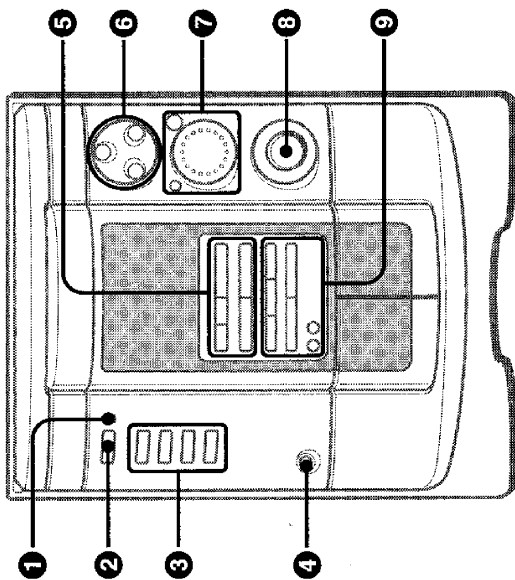

- 1 DEMO/ECO**
When the unit is turned off: switches DEMO on and off.
When the unit is turned on: enters ECO or dimmer setting mode.
- 2 POWER \odot STANDBY/ON**
Switches the unit on and off (standby).
- 3 TAPE DECK 1/2**
Selects Tape function, and deck 1 or 2.
- TUNER/BAND**
Selects Radio function and the radio band.
- VIDEO/AUX**
Selects the function of external equipment connected to VIDEO/AUX jacks.
- CD**
Selects CD function.
- 4 PHONES jack**
Plug in here an optional headphones set with a standard stereo plug ($\varnothing 6.3$ mm). Speaker output is canceled.
- 5 IISET**
CD and Tape: pauses playback.
Radio: stores the received station to preset.
- CLEAR**
CD and Tape: stops playback.
Radio: clears a station preset.
- ▶ PRESET**
CD and Tape: starts playback.
Radio: tunes into a preset station.
- ◀/I/◀◀DOWN, ▶▶/▶▶UP TUNING**
CD: skips to a previous or a succeeding track when pressed, searches a track in fast forward or fast reverse playback when held down.
Tape: fast forwards or rewinds the tape.
Radio: manually tunes down or up within the band.
- 6 GEQ**
Selects a sound equalization curve.
- BBE**
Enhances high frequency sound.
- T-BASS**
Emphasizes low frequency sound.
- 7 MULTI JOG**
CD: skips to a previous or a succeeding track.
Radio: selects a preset number.
Clock and Timer: sets the time.
ECO and Dimmer: selects the mode.
- ENTER**
Determines the mode and the time (ECO, dimmer, clock and timer).
- TIMER**
Enters timer setting mode.
- 8 VOLUME**
Adjusts the volume.
- 9 DISC DIRECT PLAY 1-3**
Selects a CD tray.
- DISC CHANGE**
Rotates the CD trays.
- ▲OPEN/CLOSE**
Opens or closes the disc compartment.
- SYNC DUB**
Starts dubbing a whole tape.
- REC/REC MUTE**
Starts recording.

Remote control

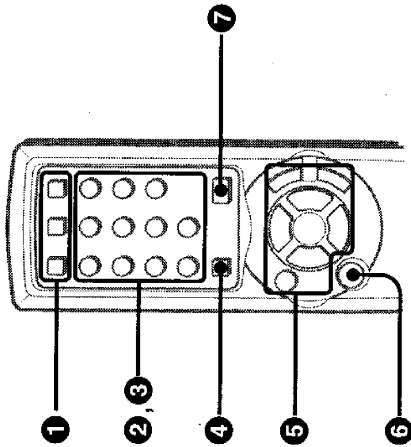

Buttons with same or similar names with the main unit basically have the same function.

1 DISC DIRECT PLAY 1-3

2 0-9, +10

CD: selects a CD track of the specified number.

Radio: tunes in to the station with the specified preset number.

3 The numbered buttons take on these functions when pressed together with SHIFT held down:

CD EDIT/CHECK

Displays the remaining playback time of a CD when pressed during playback.

Enters AI Edit Recording or Programmed Edit Recording mode when pressed during stop.

PRGM

Enters programmed CD playback mode.

RANDOM/REPEAT

Enters random or repeat CD playback mode.

GEQ

T-BASS

TIMER

SLEEP

Enters sleep-timer setting mode.

CLOCK

Enters clock adjustment mode.

MONO TUNER

Switches between stereo or monaural FM reception.

BAND

Switches the radio band.

4 SHIFT

Hold down when pressing a numbered button to change its function to that printed above the number. *e.g.*

"Press **SHIFT+SLEEP** on the remote control" indicates "Hold down **SHIFT** and press '8' (**SLEEP**)", so that you can use 'Sleep timer' function.

5 IISET

▶PRESET

◀◀/I◀◀DOWN, ▶▶/▶▶UP TUNING

■CLEAR

VOL(∧, ∨)

6 POWER

7 FUNCTION

Switches the active function among TAPE, TUNER/BAND, VIDEO/AUX and CD.

ADJUSTMENTS BEFORE OPERATIONS

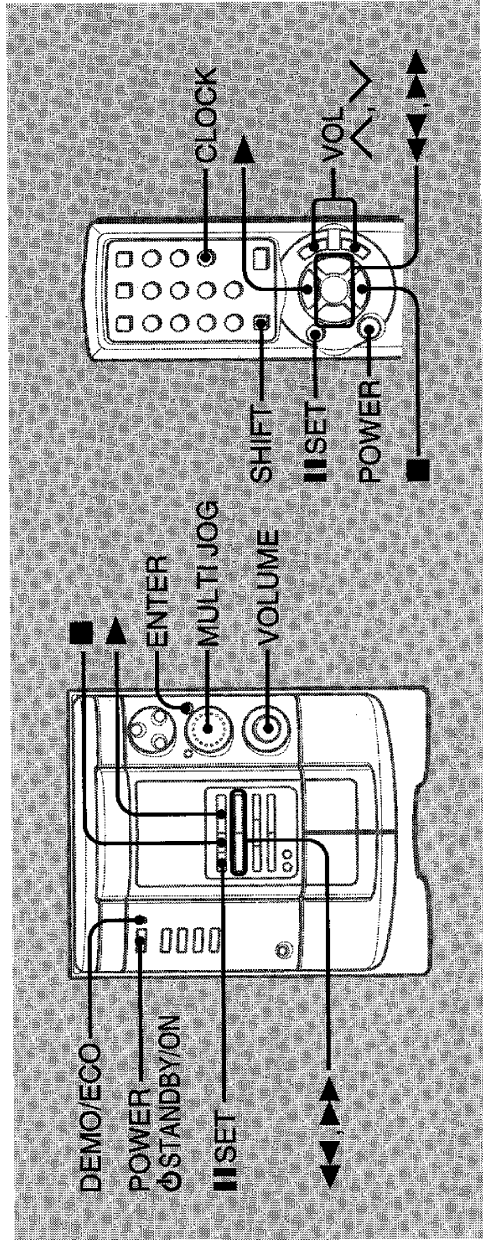

En

DEMO

If the clock has not been set, a DEMO appears on the display when the unit is turned off. There are two kinds of DEMO: "Illumination demo" and "Game demo". You can enjoy both on the unit.

To deactivate and activate the DEMO

Press DEMO/ECO when the unit is turned off.

To switch between "Illumination demo" and "Game demo"

Hold down DEMO/ECO and press POWER.

To play the Game demo

Press ► so that three numbers start to run and then press ■ three times to stop the numbers.

If the three numbers are equal, you win points. If not, you lose them.

Tip:

To change the winning probability, press ◀◀ or ▶▶ so that the CD tray number indicator changes between 1 (lowest) and 3 (highest).

Volume

Turn VOLUME (Press VOL ▲, ▼ on the remote control).

Adjust from 0 (minimum) to 30 and MAX (maximum).

Tip:

Volume level setting is retained during power-off standby. If the unit is turned off with the volume set to 17 or more, it is automatically turned down to 16 the next time the unit is turned on.

Power

Turning the unit on

Press POWER ⏻ STANDBY/ON (POWER on the remote control).

Or press TAPE, TUNER/BAND, VIDEO/AUX or CD, the playback will start automatically if a disc or tape is inserted.

Turning the unit off

Press POWER ⏻ STANDBY/ON again.

The unit goes into standby.

ECO mode

Reduces power consumption with the following operations, etc.

ECO ON mode

- The unit blacks out when the unit is turned off. Only the red indicator lights up. (Only when the clock is set.)
- If dimmer mode is set to on, the unit illumination brightens (for 10 seconds) only when you operate the unit.
- When the unit turns on with the timer recording, the dimmer mode is set to dimmest and the volume is set to minimum.

ECO AUTO mode

- In addition to the operations of ECO ON mode, the unit automatically turns itself off if you do not operate the unit and the sound source is mute for 10 minutes.

1 Press DEMO/ECO once when the unit is turned on, and then within 4 seconds press ENTER.

2 Turn MULTI JOG to select one of the ECO modes and then press ENTER.

If there is no MULTI JOG or button operation within 4 seconds, the setting is canceled.

To cancel the ECO mode

Repeat the above and select "ECO OFF".

Dimmer

Adjusts the brightness of the display.

1 Press DEMO/ECO twice when the unit is turned on, and then within 4 seconds press ENTER.

2 Turn MULTI JOG to select one of the three dimmer modes or "DIM-OFF", and then press ENTER. "DIM-OFF" is the brightest and "DIMMER 3" is the dimmest.

If there is no MULTI JOG or button operation within 4 seconds, setting is canceled.

To cancel the dimmer

Repeat the above and select "DIM-OFF".

Setting the clock

1 Press SHIFT+CLOCK on the remote control.

2 Press ◀◀ or ▶▶ to set the time.

Each press changes the time in 1-minute steps. Holding it down changes the time in 10-minute steps.

If ◀◀ or ▶▶ is not pressed within 4 seconds, setting is canceled.

- MULTI JOG is also available in place of ◀◀ or ▶▶.

3 Press ENTER or IISET.

The time display stops flashing and the clock starts from 00 seconds.

To display the time

Press SHIFT+CLOCK on the remote control.

The time will be displayed for 4 seconds, but it cannot be displayed during recording.

To switch to the 24-hour standard

Display the time and press ■ within 4 seconds.

With each press, the clock alternates between the 12-hour standard and the 24-hour standard.

Tip:

In the 12-hour standard, "AM 12:00" indicates midnight and "PM 12:00" noon.

If the clock display flashes when the unit is turned off

There has been a power interruption. Re-set the clock.

CD OPERATIONS

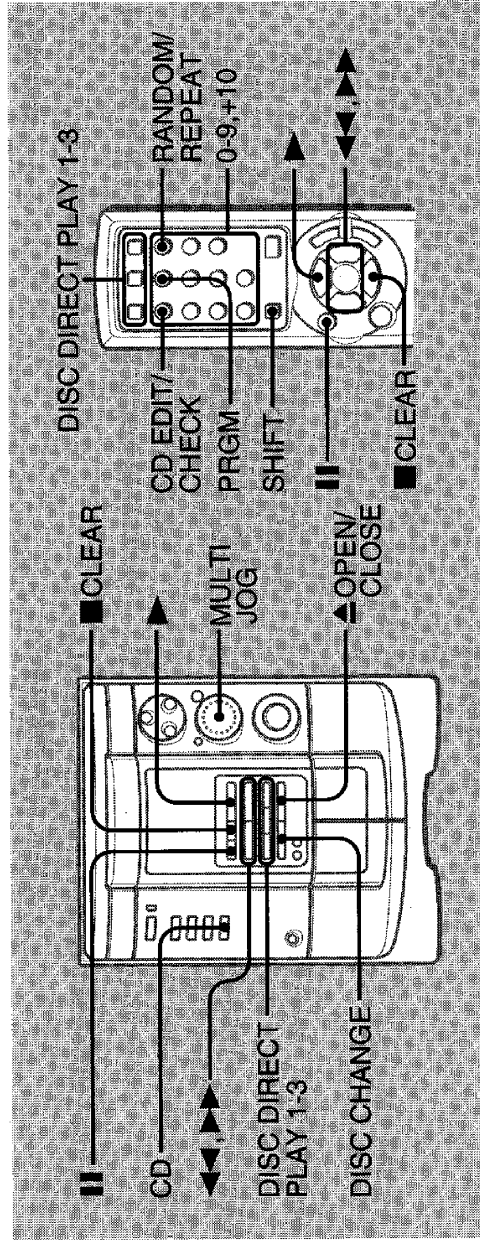

This unit plays back finalized CD-R/RW discs as well as audio CDs.

Playback

- 1 Press CD and load disc(s)**
 Press **▲** OPEN/CLOSE to open the disc compartment and place one or two disc(s) with the labeled side up. To place three discs, press DISC CHANGE so that the trays rotate, then place the third one. Lastly, close the compartment with **▲** OPEN/CLOSE.
 • When loading an 8-cm (3-inch) disc, place it on the inner circle of the tray.
 - 2 To play all discs, press ▲.**
 To play one desired disc, press DISC DIRECT PLAY 1-3.
- To stop playback**
 Press **■**.
- To pause playback**
 Press **II**. Press again to resume playback.

To replace disc(s) during playback without interruption

While one disc is being played back, press DISC CHANGE so that the compartment opens, replace disc(s) with other one(s), and press DISC CHANGE to close the compartment.

Random/Repeat playback

Random playback plays all the tracks on one desired disc or all the discs in random order. Repeat playback plays all the tracks repeatedly on one desired disc or all the discs.

- 1 Press SHIFT+RANDOM/REPEAT repeatedly on the remote control to select one of the following modes:**

 - Random playback: "RANDOM" lights up.
 - Repeat playback: "↶" lights up.
 - Random and repeat playback: "RANDOM" and "↶" lights up.

- 2 To play one desired disc, press DISC DIRECT PLAY 1-3.**
 To play all discs, press **▲**.

To cancel random/repeat playback

Press SHIFT+RANDOM/REPEAT repeatedly on the remote control so that both "RANDOM" and "↶" disappear on the display.

To repeat a selected set of tracks

Select the tracks with programmed playback, then press SHIFT+RANDOM/REPEAT on the remote control to select repeat playback.

- It is impossible to play a selected set of tracks in random order.

To skip to the beginning of the current/preceding/succeeding track

Press **◀◀** or **▶▶** repeatedly or turn MULTI JOG.

To search (playback in fast forward or fast reverse)

Hold down **◀◀** or **▶▶**. Release at the desired point.

To select a track with the remote control

Press DISC DIRECT PLAY 1-3 to select a disc and then press the numbered buttons to select a track.
 - To select track 25, press +10, +10 and 5.
 - To select track 10, press +10 and 0.

To display the remaining playback time of the CD

Press SHIFT+CD EDIT/CHECK on the remote control. Press again to return to the elapsed time display.

- Remaining playback time cannot be displayed during random playback or programmed playback.

Programmed playback

Plays back up to 30 selected tracks in programmed order.

- 1 Press SHIFT+PRGM on the remote control during stop.
"PRGM" lights up on the display.
- 2 Press DISC DIRECT PLAY 1-3 to select a disc.
Go to the next step when the tray stops rotating.
- 3 Press the numbered buttons on the remote control to program a track.
The selected track number lights up on the display.
-To select the 25th track, press +10, +10 and 5.
-To select the 10th track, press +10 and 0.

- 4 Repeat step 2 and 3 to program other tracks.

5 Press ►.

- During programmed playback, you cannot select a disc or a track with the numbered buttons. "CAN'T USE" is displayed when you try to select a track.
- If the total playback time of the program exceeds 99:59 minutes, or if a track with a track number exceeding 30 is programmed, the playing time is displayed as "--:--".
- You cannot program more than 30 tracks. "FULL" is displayed.

To check the program

Press ◀◀ or ▶▶ repeatedly during stop. The disc number, track number and program number are displayed in succession.

To clear the program

Press ■ CLEAR during stop. "PRGM" disappears on the display.

To add tracks to the program

Repeat step 2 and 3 before starting playback. The tracks are added to the end of the program.

To change the programmed tracks

Clear the program and reselect the tracks in your desired order.

Notes on CDs

- Do not place more than one disc on one tray.
- Do not tilt the unit with discs loaded.
- The unit may not play a CD-R/RW disc recorded on personal computers or certain kinds of CD-R/RW recorders.
- Do not attach adhesive label, etc. to either side of a CD-R/RW disc, as doing so may cause malfunction.
- Do not load an unrecorded CD-R/RW disc. The disc may be damaged.
- Do not use irregular-shaped CDs.

RADIO OPERATIONS

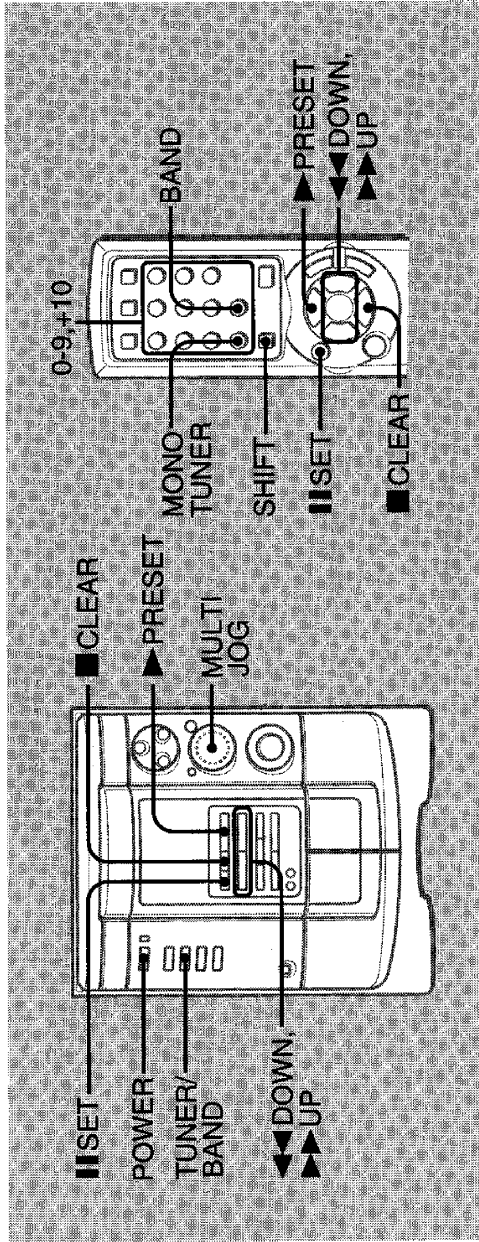

Tuning in to preset stations

On the unit

- 1 Press **TUNER/BAND** to select the band.
- 2 Press **PRESET** repeatedly or turn **MULTI JOG**.
With each press, the station with the succeeding preset number is tuned in.

On the remote control

- 1 Press **SHIFT+BAND** to select the band.
- 2 Press the numbered buttons for the preset number of your desired station.
 - To select preset number 20, press +10, +10 and 0.
 - To select preset number 15, press +10 and 5.

Manual tuning

- 1 Press **TUNER/BAND (SHIFT+BAND)** on the remote control) repeatedly to select a band.
The unit switches to the radio from any other function and alternates between FM and AM.

- 2 Press **<<DOWN** or **>>UP** to tune in to a station.
"TUNE" is displayed when a station is tuned in.
"(()))" lights up for FM stereo reception.

To search for a station automatically (Auto Search)

Hold down **<<DOWN** or **>>UP**.
The unit searches for a station up or down the band and stops at reception.

- To stop the search manually, press **<<DOWN** or **>>UP**.
- Auto Search may not stop at stations with weak signals.

Preset tuning

Preset your favorite stations and tune them in directly.

Presetting stations

- 1 Press **TUNER/BAND** to select the band.
- 2 Press **<<DOWN** or **>>UP** to tune in to the desired station.
- 3 Press **II SET** to store the station.
The preset number, beginning from "1", appears on the display.
- 4 Repeat step 1 to 3 to preset other stations.
 - You cannot store more than a total of 32 preset stations. "FULL" is displayed.

To clear a preset station

- 1 Tune in to the station by preset tuning.
- 2 Press **II CLEAR**, then press **II SET** within 4 seconds.
Preset numbers of preset stations in the band with higher numbers decrease by one.

Adjustments

Antennas

Keep antennas away from metallic objects, electrical equipment and cords.

FM antenna: Extend fully in a T-shape. If receiving condition is poor, connect optional outdoor antenna to FM 75 Ω terminal. Be sure to connect the shield braid of the antenna to the \blacktriangleleft terminal.

AM antenna: Rotate to find best reception.

To switch to monaural FM reception

Press SHIFT+MONO TUNER on the remote control. With each press, "MONO" and "STEREO" are displayed alternately on the display.

Tip:

When FM stereo reception is poor, switching to monaural reduces noise.

To switch the AM tuning interval

Hold down TUNER/BAND and press POWER. With each press, the AM tuning interval alternates between 9 kHz/step and 10 kHz/step.

Tip:

The default is 10 kHz/step. Change it only when using the unit in a 9 kHz/step area. Switching AM tuning interval clears all the preset stations.

TAPE OPERATIONS

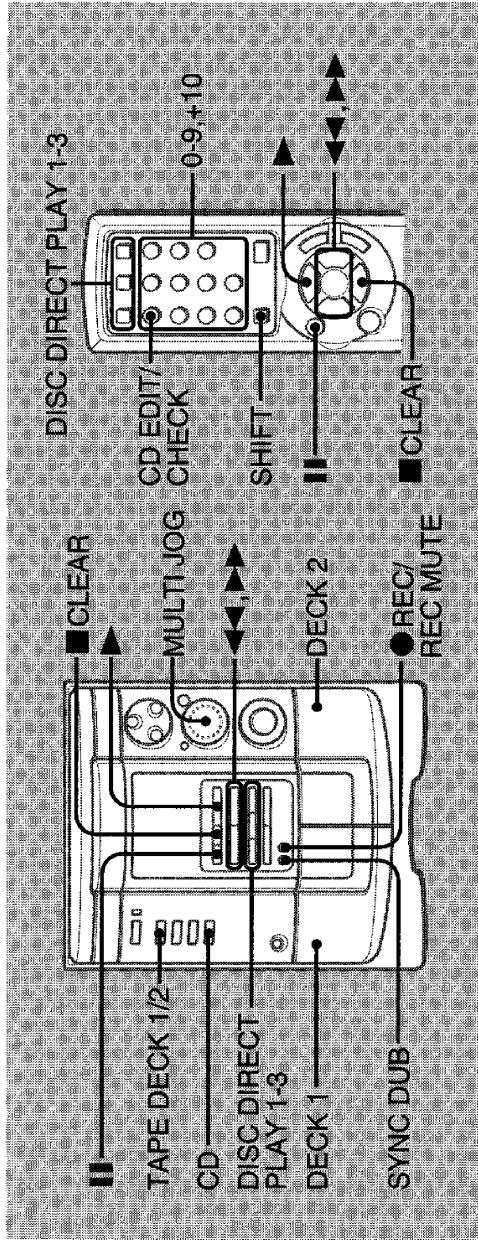

Notes on cassettes

- Use of 120-minute or longer tapes is not recommended since they are extremely thin and easily deformed or damaged.
- Take up any slack in the tape with a pencil or similar tool before use. Slack tape may jam in the mechanism.
- "SOFT" sound for type II tapes described above is canceled when the graphic equalizer is turned on, the cassette holder is opened, the function is changed, or the unit is turned off.

Basic recording

Use only type I (normal) tapes. DECK 2 is the recording deck. Only one side of the tape can be recorded at a time.

- 1 Insert the recording tape in DECK 2.
Press **▲** PUSH EJECT to open the cassette holder, and insert with the exposed side down and the side to be recorded on facing out from the unit.
Wind up the tape to the desired point if needed.
- 2 Prepare the source.
To record CD(s), select the CD function and load disc(s).
To record a radio broadcast, tune in to the desired station.
To record a tape, select the tape function and insert the source tape in DECK 1.
To record from connected external equipment, select the VIDEO (AUX/TV) function and prepare the equipment.
- 3 Press **●** REC/REC MUTE to start recording.
When recording a CD or tape, playback starts automatically.
When recording input from connected equipment, manually start playback of the source.

To fast forward or rewind

Press **◀◀** or **▶▶**.

To select a deck (DECK 1 or DECK 2)

Press TAPE in stop mode when tapes are loaded in both decks. The deck number ("TP1" or "TP2") is displayed.

To reset the tape counter

Press **■** CLEAR in stop mode, and the tape counter on the display is reset to "0000".
Opening and closing the cassette holder will also reset the tape counter.

To play continuously (DECK 1 to DECK 2)

Load tapes in both decks and start playback on DECK 1. Then, as soon as playback on DECK 1 finishes, playback on DECK 2 will start without interruption.

To play back type II (High position) tapes

Turn MULTI JOG until "SOFT" is displayed while playing a type II tape.
Then, the unit provides the optimum playback sound for type II tapes.

Playback

Use only type I (normal) tapes.

- 1 Press TAPE and insert the tape in either deck.
Press **▲** PUSH EJECT to open the cassette holder, and insert with the exposed side down and playback side facing out from the unit. Push the cassette holder to close.

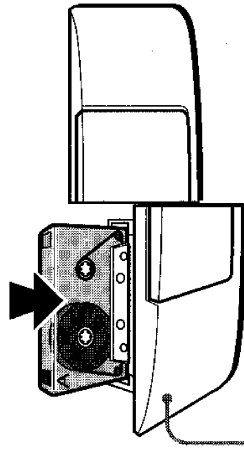

▲ PUSH EJECT

- 2 Press **▶**.

To stop playback

Press **■**.

To pause playback (DECK 2 only)

Press **||**. Press again to resume.

- When recording on tape, close the disc compartment before starting to record.
- Volume or tone (except BBE) adjustment does not affect recording.
- "CAN'T REC" is displayed if you attempt to record a tape with the tab broken off.

To stop recording

Press ■.

To pause recording (only for TUNER or VIDEO/AUX source)

Press ■■. Press again to resume.

To record a selected set of tracks from a CD

Program the desired tracks (see "Programmed playback") and then press ●REC/REC MUTE.

To record a 4-second blank space (only for TUNER or VIDEO/AUX source)

1 Press ●REC/REC MUTE during recording or in recording pause mode.

"REC" flashes on the display for 4 seconds (a blank space is made in the meantime) and then the unit enters recording pause mode.

To record less than a 4-second blank space, press ●REC/REC MUTE again while "REC" flashes.

To record more than a 4-second blank space, press ●REC/REC MUTE again after the unit enters recording pause mode. Each time the button is pressed, a 4-second blank space is added.

2 Press ■■ to resume recording.

To erase a tape

1 Insert the tape in DECK 2. Set the tape to the desired point if needed.

2 Press TAPE to select "TP2".

3 Press ●REC/REC MUTE.

Whole tape dubbing

- 1 Press TAPE.
 - 2 Insert the original tape in DECK 1 and the recording tape in DECK 2.
 - 3 Press SYNC DUB.
The tapes are rewound to the beginning of the front side and recording starts.
- Dubbing cannot start from a point halfway in the tape.
 - Only one side of the tape can be recorded at a time.

To stop dubbing

Press ■.

Edited CD recording

AI Edit Recording

When recording a whole CD, AI Edit Recording takes the length of your tape into account and rearranges the recording order of the tracks if necessary, so that no track is cut short at the end of the side. Prepare a tape long enough to record the CD.

- 1 Insert the recording tape in DECK 2.
- 2 Press CD to select the CD function and load the disc.
- 3 Press SHIFT+CD EDIT/CHECK once on the remote control.
The "EDIT" indicator lights up and "AI C-00" appears on the display.
- 4 Press DISC DIRECT PLAY 1-3 to select a disc.

- 5 Press the numbered buttons on the remote control to enter the length of the recording tape. 10 to 99 minutes can be specified.

- For a 60-minute tape press 6 and 0.

In a few seconds, the unit determines the tracks to be recorded for each side.

The recording time left for side A appears on the display.

- ◀◀, ▶▶ or MULTI JOG can also be used to specify tape length.

- 6 Press ●REC/REC MUTE to start recording on side A.

The tape is rewound to the beginning of side A and recording starts.

Go to the next step when recording on side A finishes.

- 7 Press SHIFT+CD EDIT/CHECK once on the remote control.

The recording time left for side B appears on the display.

- 8 Turn over the tape and press ●REC/REC MUTE to start recording on side B.

- AI Edit Recording cannot be used with discs with more than 30 tracks. "TR OVER" is displayed.

- Recording cannot start from a point halfway in the tape.

Programmed Edit Recording

As you program the CD tracks to record, Programmed Edit Recording displays the remaining recording time for each side of the tape, so you can easily select a set of desired tracks within the length of your tape.

- 1 Insert the recording tape in DECK 2.
- 2 Press CD to select the CD function and load the disc.
- 3 Press SHIFT+CD EDIT/CHECK twice on the remote control.
The "PRGM" and "EDIT" indicators light up and "PRGMC-00" appears on the display.
- 4 Press the numbered buttons on the remote control to enter the length of the recording tape.
10 to 99 minutes can be specified.
• ◀◀, ▶▶ or MULTI JOG can also be used to specify tape length.
- 5 Press DISC DIRECT PLAY 1-3 to select a disc.
Then, press the numbered buttons on the remote control to select the first track to be recorded on side A.
-To select the 25th track, press +10, +10 and 5.
-To select the 10th track, press +10 and 0.
- 6 Repeat step 5 to select the rest of the tracks for side A.
The remaining recording time of side A is displayed. You cannot select a track with a longer playing time.
- 7 Press SHIFT+CD EDIT/CHECK on the remote control to switch to side B and select the tracks for the side.

To prevent accidental erasure

Break off the plastic tab of the cassette tape with a screwdriver or other pointed tool. To record on the tape again, cover the detection slot with adhesive tape.

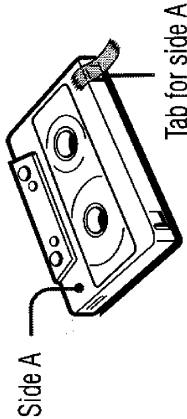

- 8 Press SHIFT+CD EDIT/CHECK on the remote control to switch back to side A and press ● REC/REC MUTE to start recording on side A.
The tape is rewound to the beginning of side A and recording starts.
Go to the next step when recording on side A finishes.
- 9 Press SHIFT+CD EDIT/CHECK on the remote control to switch to side B, turn over the tape, and press ● REC/REC MUTE to start recording on side B.
 - You cannot program more than 30 tracks. "FULL" is displayed.
 - You cannot program a track with a track number larger than 30.
 - Recording cannot start from a point halfway in the tape.

To stop recording

Press ■ . Recording and CD playback stop simultaneously.

To check the program

- 1 Before recording, press SHIFT+CD EDIT/CHECK on the remote control to select side A or B.
- 2 Press ◀◀ or ▶▶ repeatedly. The track number and program number are displayed in succession.

To change the program of each side

Press SHIFT+CD EDIT/CHECK on the remote control to select side A or B, and press ■ CLEAR to clear the program for the selected side. Then, select tracks again.

To clear the edit program

Press ■ CLEAR twice so that "EDIT" disappears from the display.

SOUND ADJUSTMENTS

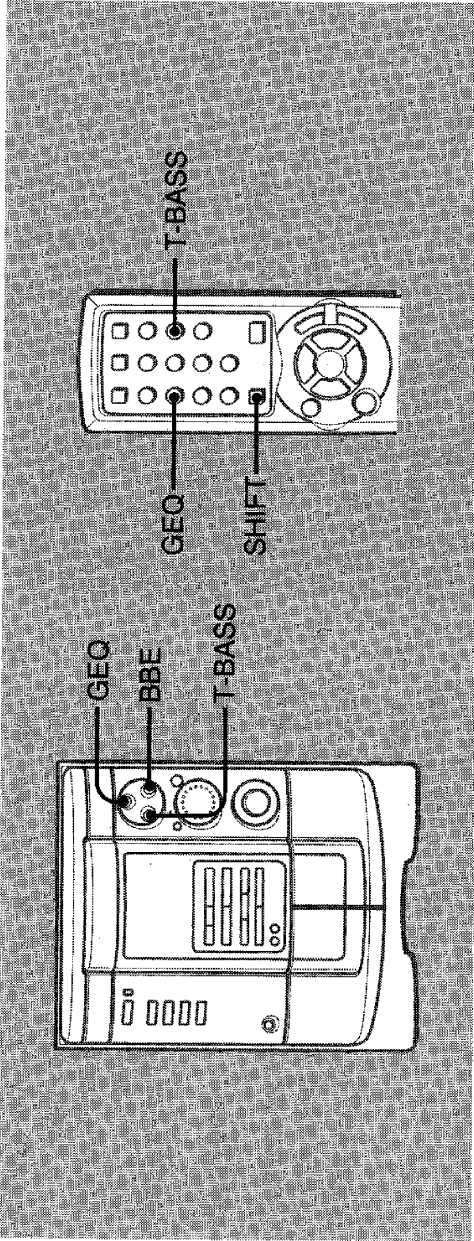

En

Graphic equalizer

Selects a sound equalization curve to match the music type.

Press GEO (SHIFT+GEO on the remote control) repeatedly to select one of the three equalization curves.

- ROCK: Powerful sound emphasizing treble and bass
- POP: More presence in the vocals and midrange
- CLASSIC: Enriched sound with heavy bass and fine treble

To display the current GEO mode

Press GEO (SHIFT+GEO on the remote control) once. The mode will be displayed for 4 seconds.

To cancel equalization

Press GEO (SHIFT+GEO on the remote control) repeatedly until "GEO OFF" is displayed.

BBE

Enhances high frequency for sound clarity.

Press BBE repeatedly to select one of the three enhancement levels or the off position.

- When the sound becomes distorted with the BBE effect, cancel it.

Super T-BASS

Emphasizes low frequencies for a powerful sound.

Press T-BASS (SHIFT+T-BASS on the remote control) repeatedly to select one of the three emphasis levels or the off position.

- When the sound becomes distorted with the T-BASS effect, cancel it.

TIMER OPERATIONS

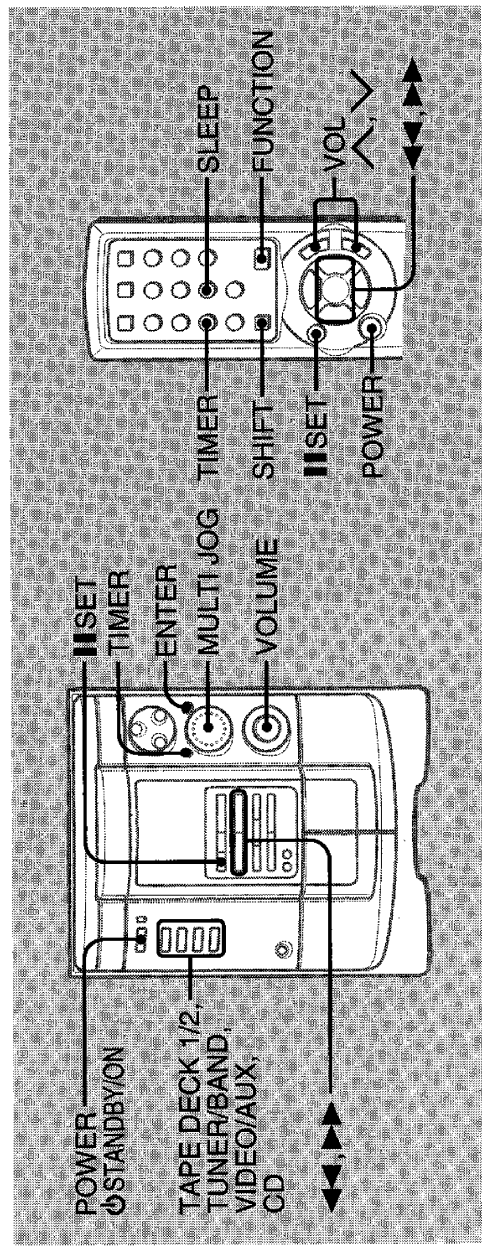

Sleep timer

Turns off the unit automatically after a specified time.

- 1 Press SHIFT+SLEEP on the remote control. "SLEEP" appears on the display.
- 2 Press ◀◀ or ▶▶ repeatedly to set the sleep timer duration.
 - With each press, the timer duration changes in 5-minute steps between 5 to 240 minutes. If there is no button input for 4 seconds, the current setting is entered automatically. The unit turns off after the selected time.
 - MULTI JOG is also available in place of ◀◀ or ▶▶.

Tip:

The display is dimmed while the sleep timer is active.

To check the remaining time until the unit turns off

Press SHIFT+SLEEP on the remote control. The remaining time is displayed for 4 seconds.

To cancel the sleep timer

Press SHIFT+SLEEP twice on the remote control so that "SLEEP OFF" is displayed.

- 4 Press ◀◀ or ▶▶ to set the timer-activated duration, then press IISET or ENTER. With each press, the timer-activated duration changes in 5-minute steps between 5 to 240 minutes. If there is no button input for 4 seconds, the current setting is entered automatically.
 - MULTI JOG is also available in place of ◀◀ or ▶▶.

- 5 Adjust the volume and tone for timed playback. If the volume level is set to 17 or higher, it is automatically turned down to 16 when the unit is turned on by the timer.

6 Prepare the source.

To play CD(s), load disc(s).

To play the radio, select the band and tune in to the desired station.

To play a tape, insert the tape.

To play external equipment connected to the VIDEO/AUX jacks, set an external timer for the equipment so that its playback begins at the same time.

- 7 Press POWER STANDBY/ON to turn the unit off.

"⊕" remains on the display to indicate the timer standby mode.

At timer-on time, the unit turns on and plays the selected source. After the specified timer-activated duration, the unit turns off again.

- Timer playback will not begin unless the unit is turned off first.

- Connected equipment cannot be turned on or off by the built-in timer of this unit. Use an external timer.

- The timer source can be changed with the function buttons before completing step 3.

Timer playback

Turns on the unit at a specified time for the specified duration. Make sure the clock is set correctly.

- 1 Press one of the function buttons to select the desired playback source.
- 2 Press TIMER (SHIFT+TIMER on the remote control). "⊕" indicator lights up and "⊕ PLAY" appears on the display. Then, the timer-on time and the source name appear alternately on the display.
- 3 Press ◀◀ or ▶▶ to set the timer-on time, then press IISET or ENTER.
 - If ◀◀ or ▶▶ is not pressed within 6 seconds, you will exit the timer setting mode and the previous setting, however, is entered.
 - MULTI JOG is also available in place of ◀◀ or ▶▶.

To display the timer setting

Press **TIMER**.

The timer-on time, the source and the timer-activated duration are displayed for 6 seconds.

Tip:

Timer setting can be displayed even while the unit is turned off, and at that time if you press **ENTER** or **■** within 6 seconds after **TIMER** is pressed, you can enter the timer setting mode and change the setting.

To change the timer setting

Re-set the timer again.

To cancel the timer

Press **TIMER** repeatedly until "**OFF**" is displayed. "**OFF**" disappears from the display.

Tip:

Your timer setting is retained even if the timer is canceled. Next time the timer is activated, you can change your previous setting, or simply use the same setting again.

Timer recording

Timer recording is available only for **TUNER** and **VIDEO/AUX** (with an external timer) sources.

- 1 Press either **TUNER/BAND** or **VIDEO/AUX** to select a source.
- 2 Press **TIMER** repeatedly until "**REC**" appears on the display.
- 3 Carry out step 3 to step 5 described in "Timer playback".
- 4 Prepare the source.
To record the radio, select the band and tune in to the desired station.
To record external equipment connected to the **VIDEO/AUX** jacks, set an external timer for the equipment so that its playback begins at the same time.
- 5 Insert the recording tape in **DECK 2** and then turn the unit off.

REFERENCE

Care and maintenance

Occasional care and maintenance of the unit and the software are needed to optimize the performance of your unit.

To clean the cabinet

Use a soft and dry cloth. If the unit surfaces are extremely dirty, use a soft cloth lightly moistened with mild detergent solution. Do not use strong solvents such as alcohol, benzine or thinner.

To clean the tape heads

Dirty tape heads cause sound deterioration. After every 10 hours of use, clean the tape heads with a head cleaning cassette. Refer to the instructions of the cleaning cassette.

To demagnetize the tape heads

Use a demagnetizing cassette after every 20 to 30 hours of use. Refer to the instructions of the demagnetizing cassette.

Care of CDs

When a CD becomes dirty, wipe it from the center out with a cleaning cloth. After playing a CD, store it in its case. Do not keep it in hot or humid places.

Care of tapes

Store tapes in their cases after use. Do not leave tapes near magnets, motors, television sets, or any source of magnetism. Do not expose tapes to direct sunlight, or leave them in a car parked in direct sunlight.

Troubleshooting

If your unit fails to perform properly, check the following guide and the relevant sections of the Operating Instructions.

There is no sound.

- Are the speakers and AC power cord connected properly?

The unit shut off suddenly.

- Possibly a short circuit in the speaker terminals. Disconnect the AC power cord from the AC power outlet and re-connect the speaker cords correctly.

The unit blacks out when the unit is turned off.

- Is ECO mode set to on?

Erroneous display.

- Reset the unit.

Poor radio reception.

- Check antenna connection. Adjust the antenna to find the best reception.
- Move unit and antenna away from other electric appliances and cords.

The tape does not run.

- Is the deck in pause?

Poor tape sound.

- Check for dirty heads. Clean them if needed.
- Use type I (normal) tapes.

Cannot record.

- Is the erasure prevention tab of the tape broken off? If so, cover the detection slot with adhesive tape.

The CD player works poorly.

- Is the disc correctly loaded?
- Is the disc dirty?
- Is the lens affected by condensation? If so, wait approximately one hour and try again.

Resetting the unit

If an unusual condition occurs in the display window or the cassette deck, reset the unit as follows:

- 1 Press POWER to turn off the power.

If the power cannot be turned off, disconnect the AC power cord, then plug it in again.

- 2 Hold down **■** and press POWER.

Everything stored in memory after purchase is cleared.

Specifications

MAIN UNIT CX-NAJ310

TUNER

FM tuning range 87.5 MHz to 108 MHz
FM usable sensitivity (IHF) 13.2 dBf
FM antenna terminals 75 ohms (unbalanced)
AM tuning range 530 kHz to 1710 kHz (10 kHz step)
531 kHz to 1602 kHz (9 kHz step)
AM usable sensitivity 350 μ V/m
AM antenna Loop antenna

AMPLIFIER

Power output 60 W + 60 W (50 Hz - 20 kHz, THD less than 1 %, 6 ohms)
75 W + 75 W (1 kHz, THD less than 10 %, 6 ohms)
Total harmonic distortion 0.08 % (30 W, 1 kHz, 6 ohms, DIN AUDIO)

Input

VIDEO/AUX: 500 mV

Outputs

SPEAKERS: 6 ohms or more
PHONES: 32 ohms or more

CASSETTE DECK

Track format 4 tracks, 2 channels stereo
Frequency response 50 Hz - 15 kHz
Recording system AC bias
Heads DECK 1: playback x 1
DECK 2: recording/playback x 1, erase x 1

CD PLAYER

Laser Semiconductor laser ($\lambda = 780$ nm)
D/A converter 1 bit dual
Signal-to-noise ratio 85 dB (1 kHz, 0 dB)
Harmonic distortion 0.05 % (1 kHz, 0 dB)

GENERAL

Power requirements 120 V AC, 60 Hz
Power consumption 70 W
Power consumption With ECO mode on: 0.6 W
in standby mode With ECO mode off: 20 W
Dimensions (W x H x D) 260 x 324 x 339 mm
(10 1/4 x 12 7/8 x 13 3/8 in.)
Weight 6.3 kg (13 lbs 14 oz)

FRONT SPEAKERS SX-NAJ312

Speaker system 3 way, bass reflex (magnetic shielded)
Speaker units Woofer: 140 mm (5 5/8 in.) cone
Tweeter: 60 mm (2 3/8 in.) cone
Super tweeter: 20 mm (13/16 in.) ceramic
Impedance 6 ohms
Dimensions (W x H x D) 220 x 324 x 225 mm
(8 3/4 x 12 7/8 x 8 7/8 in.)
Weight 4.3 kg (9 lbs 8 oz)

Specifications and external appearance are subject to change without notice.

COPYRIGHT

Check copyright laws relevant to recordings from discs, radio or tape for the country where the unit is to be used.

BBE SYSTEM

The word "BBE" and the "BBE symbol" are trademarks of BBE Sound, Inc.
Under License from BBE Sound, Inc.

NOTE

This equipment has been tested and found to comply with the limits for a Class B digital device, pursuant to Part 15 of the FCC Rules. These limits are designed to provide reasonable protection against harmful interference in a residential installation.

This equipment generates, uses, and can radiate radio frequency energy and, if not installed and used in accordance with the instructions, may cause harmful interference to radio communications. However, there is no guarantee that interference will not occur in a particular installation. If this equipment does cause harmful interference to radio or television reception, which can be determined by turning the equipment off and on, the user is encouraged to try to correct the interference by one or more of the following measures:

- Reorient or relocate the receiving antenna.
- Increase the separation between the equipment and receiver.
- Connect the equipment into an outlet on circuit different from that to which the receiver is connected.
- Consult the dealer or an experienced radio/TV technician for help.

CAUTION

Modifications or adjustments to this product, which are not expressly approved by the manufacturer, may void the user's right or authority to operate this product.

For assistance and information
call toll free 1-800-BUY-AIWA
(United States and Puerto Rico)

 **AIWA CO., LTD.**
<http://www.aiwa.co.jp>